

1. Find the domain and range for the function.

- A. $D: \{-6, -4, 4, 6\}; R: \{-6, -5, 3, 4\}$
- B. $D: \{-6, -4, -2, 0, 2, 4, 6\}; R: \{-6, -5, -1, 2, 3, 4\}$
- C. $D: \{-6, -4, -2, 2, 4, 6\}; R: \{-6, -5, -1, 2, 3, 4\}$
- D. $D: \{-6, -5, -1, 2, 3, 4\}; R: \{-6, -4, -2, 2, 4, 6\}$

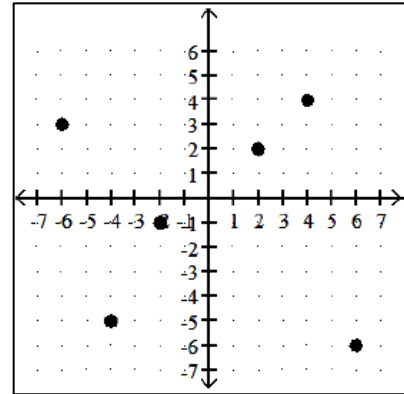

2. Find the domain and range for the function.

- A. $D: [-2, 2]; R: [-3, 0]$
- B. $D: (-\infty, 2]; R: [0, 3]$
- C. $D: [-3, 0]; R: [-2, 2]$
- D. $D: [0, 3]; R: (-\infty, 2]$

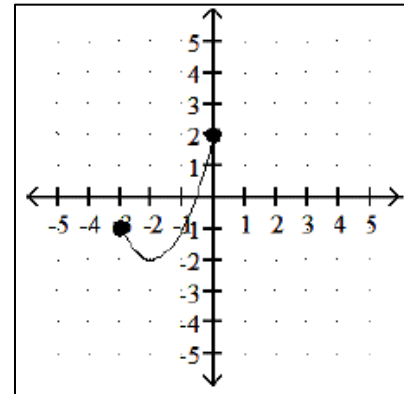

3. Given $f(x) = (x + 6)^2$, find $f(1)$.

- A. 14
- B. 49
- C. -49
- D. 25

4. Given $f(x) = x^2 - 5x - 5$, find $f(-3)$.

- A. 29
- B. -11
- C. -1
- D. 19

5. If $y = f(x)$ (pictured at the right), find $f(-2)$.

- A. 1
- B. 4
- C. -1
- D. -4

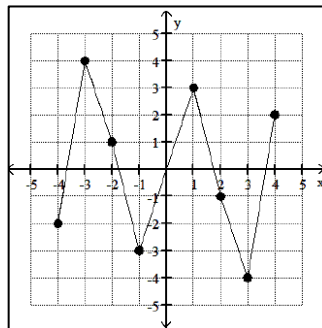

6. If $y = f(x)$ (pictured at the right) find $f(1)$.

- A. 1
- B. 4
- C. 2
- D. -4

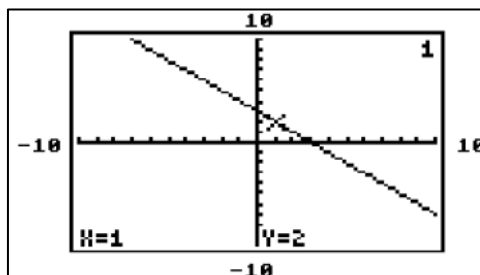

7. Employees of a publishing company received an increase in salary of 6% plus a bonus of \$500. Let $S(x) = 1.06x + 500$ represent the new salary in terms of the previous salary x . Find and interpret $S(14,000)$.

- A. \$22,900; If an employee's old salary was \$22,900, then his/her new salary is \$14,000 after the increase and bonus.
- B. \$15,340; If an employee's old salary was \$14,000, then his/her new salary is \$15,340 after the increase and bonus.
- C. \$12,736; If an employee's old salary was \$12,736, then his/her new salary is \$14,000 after the increase and bonus.
- D. \$14,500; If an employee's old salary was \$14,000, then his/her new salary is \$14,500 after the increase and bonus.

8. The function $E(x) = 0.0049x^3 - 0.0032x^2 + 0.188x + 1.87$ gives the approximate total earnings of a company, in millions of dollars, where $x = 0$ corresponds to 2006, $x = 1$ corresponds to 2007, and so on. This model is valid for the years from 2006 to 2010. Determine the earnings for 2007. Round to two decimal places if necessary.

- A. \$2.06 million
- B. \$1.87 million
- C. \$2.07 million
- D. \$2.27 million

9. Graph the function $y = \frac{-4}{x-6}$

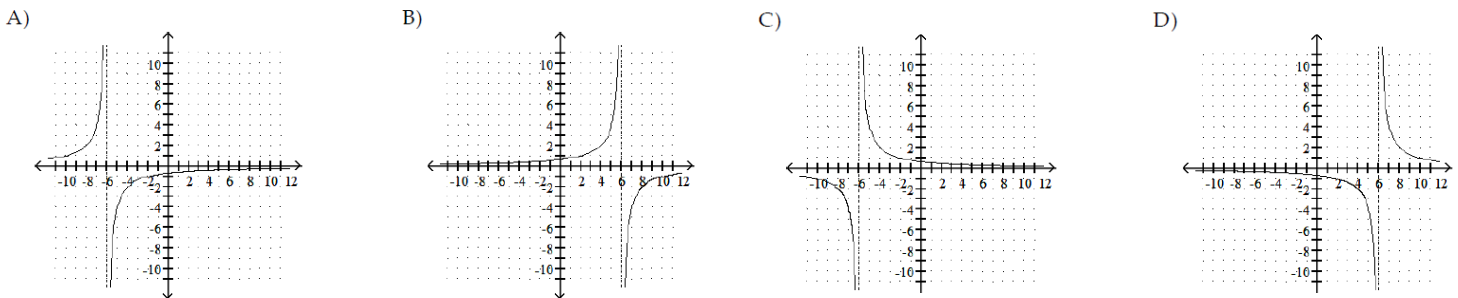

10. Find the slope of the line pictured in the graph to the right.

- A. -1
- B. 2
- C. -2
- D. 1

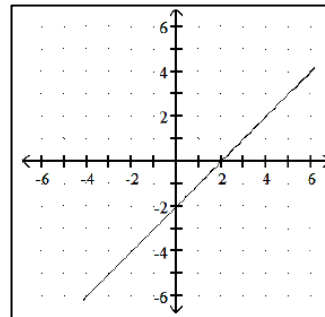

11. Find the slope of the line pictured in the graph to the right.

- A. 0
- B. 7
- C. -7
- D. *undefined*

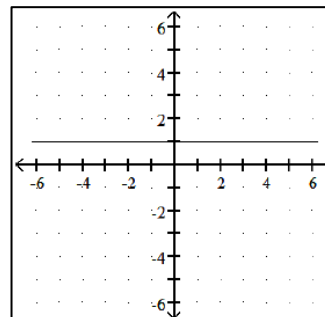

12. Find the x and y intercepts of the graph of the given equation, if they exist. Then graph the equation: $x = -4$

A) x : none; y : $(0, -4)$

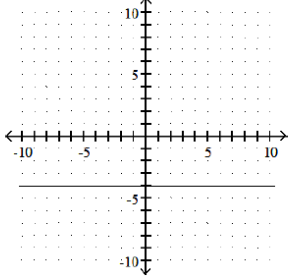

B) x : none; y : $(0, -4)$

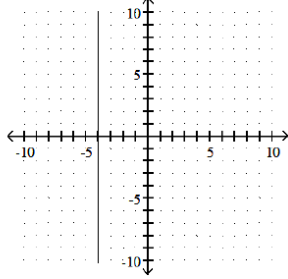

C) x : $(-4, 0)$; y : none

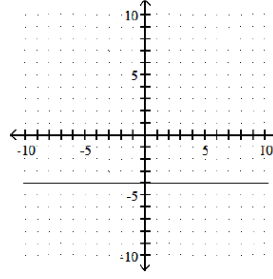

D) x : $(-4, 0)$; y : none

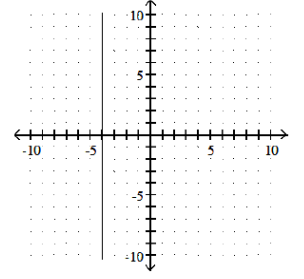

13. Find the x and y intercepts of the graph of the given equation, if they exist. Then graph the equation: $3x - 9y = 18$

A) x : $(2, 0)$; y : $(0, -6)$

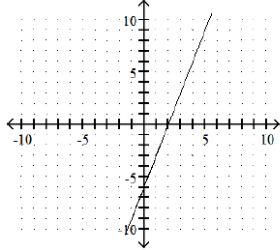

B) x : $(6, 0)$; y : $(0, -2)$

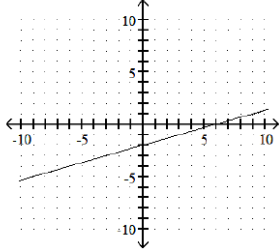

C) x : $(-2, 0)$; y : $(0, 6)$

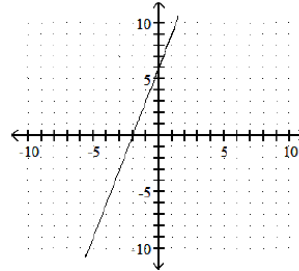

D) x : $(-6, 0)$; y : $(0, 2)$

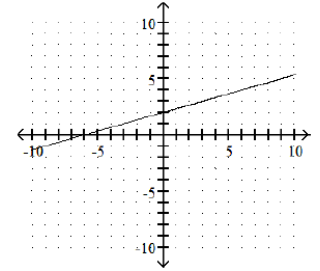

14. Write the equation of the line whose graph is shown to the right.

- A. $y = x + 3$
- B. $y = -x + 3$
- C. $y = -x - 3$
- D. $y = x - 3$

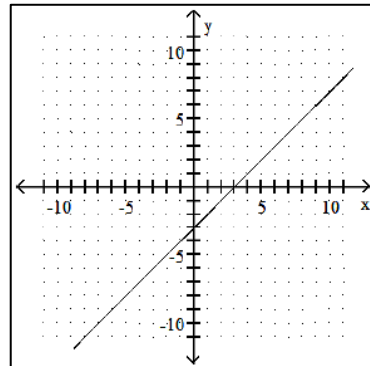

15. Write the equation of the line whose graph is shown to the right.

- A. $y = 2x + 6$
- B. $y = -2x + 6$
- C. $y = -\frac{1}{3}x + 2$
- D. $y = -3x + 6$

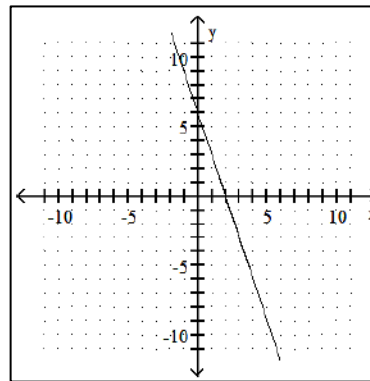

Problems 16 & 17: Write the slope-intercept equation for the line passing through the given pair of points.

16. $(-5, -3)$ and $(-1, -6)$

- A. $y = \frac{3}{4}x - \frac{27}{4}$
- B. $y = -\frac{3}{4}x - \frac{27}{4}$
- C. $y = -\frac{2}{5}x - \frac{32}{5}$
- D. $y = \frac{2}{5}x - \frac{32}{5}$

17. (9, 5) and (0, -3)

A. $y = -\frac{8}{9}x - 3$ B. $y = -\frac{4}{3}x - 3$ C. $y = \frac{8}{9}x - 3$ D. $y = \frac{4}{3}x - 3$

18. A boat is moving away from the shore in such a way that at time t hours its distance from shore, in kilometers, is given by the linear function $d(t) = 3.5t + 6.1$. What is the rate of change of the boat's distance from shore?

A. 6.1 m/s B. 3.5 m/s C. 6.1 km/hr D. 3.5 km/hr

19. The cost of tuition at a community college is given by $C(x) = 456 + 63x$, where x is the number of credit hours. Interpret the slope of this function as a rate of change.

- A. The tuition at the community college increases by \$456 for each additional 63 credit hours.
- B. The number of credit hours increases by 63 for each increase of \$456 in tuition.
- C. The tuition at the community college increases by \$63 for each additional credit hour.
- D. The tuition at the community college increases by \$456 for each additional credit hour.

20. Find the zero of $f(x)$ if $f(x) = \frac{1}{3}x + \frac{1}{6}$.

A. $-\frac{1}{2}$ B. $\frac{1}{2}$ C. $-\frac{1}{6}$ D. $\frac{1}{6}$

21. Find the zero of $f(x)$ if $f(x) = 6x + 12$.

A. 2 B. 12 C. -12 D. -2

22. Find the zero of $f(x)$ if $f(x) = \frac{1}{2}x$.

A. -2 B. 0 C. 2 D. does not exist

23. Solve $A = \frac{1}{2}h(b_1 + b_2)$ for b_1 .

A. $b_1 = \frac{A-hb_2}{2h}$ B. $b_1 = \frac{hb_2-2A}{h}$ C. $b_1 = \frac{2A-hb_2}{h}$ D. $b_1 = \frac{2Ab_2-h}{h}$

24. Solve $A = P(1 + nr)$ for r .

A. $r = \frac{Pn}{A-P}$ B. $r = \frac{A}{n}$ C. $r = \frac{P-A}{Pn}$ D. $r = \frac{A-P}{Pn}$

25. Solve for y if $3x - 10y = -6$.

A. $y = -\frac{3}{10}x + \frac{3}{5}$ B. $y = \frac{3}{10}x + \frac{3}{5}$ C. $y = 3x + 11$ D. $y = \frac{10}{3}x - 2$

26. The graph of a certain function $y = f(x)$ and the zero of that function is given. Using this graph, find

- a. the x -intercept of the graph of $y = f(x)$ and
 b. the solution to the equation $f(x) = 0$

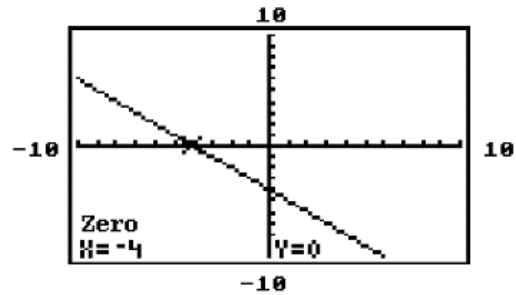

- A. a. $(0, -4)$ B. a. $(-4, 0)$
 b. $x = 0$ b. $x = -4$
- C. a. $(-4, 0)$ D. a. $(0, -4)$
 b. $x = 0$ b. $x = -4$

27. The mathematical model $C = 900x + 80,000$ represents the cost in dollars a company has in manufacturing x items during a month. How many items were produced if costs reached \$800,000?

- A. 800 items B. 711 items C. 978 items D. 799,100 items

28. Mark has \$75 to spend on salmon at \$5.00 per pound and/or chicken at \$3.00 per pound. If he buys s pounds of salmon and c pounds of chicken, the equation $5s + 3c = 75$ must be satisfied. How much salmon did Mark buy if he bought 5 pounds of chicken?

- A. 17 lb B. 12 lb C. 16 lb D. 19 lb

29. When going more than 38 miles per hour, the gas mileage of a certain car fits the model $y = 43.81 - 0.395x$ where x is the speed of the car in miles per hour and y is the miles per gallon of gasoline. Based on this model, at what speed will the car average 15 miles per gallon? (Round to the nearest whole number.)

- A. 149 mph B. 98 mph C. 73 mph D. 48 mph

30. Solve: $-5(3a - 15) < -20a + 40$

- A. $a < -20$ B. $a > -20$ C. $a > -7$ D. $a < -7$

31. Solve: $-20 < -4x \leq -4$

- A. $1 \leq x \leq 5$ B. $1 \leq x < 5$ C. $-5 < x \leq -1$ D. $1 < x < 5$

32. Solve: $-13 < 3y + 5 \leq -1$

- A. $-6 < y \leq -2$ B. $-6 < y < -2$ C. $-6 \leq y < -2$ D. $-6 \leq y \leq -2$

33. Solve: $-7 \leq -2c + 5 < -1$

- A. $-6 < c \leq -3$ B. $3 < c \leq 6$ C. $-6 \leq c \leq -3$ D. $3 \leq c < 6$

34. Solve: $-19 \leq \frac{-2-4x}{2} \leq -11$

- A. $5 < x \leq 9$ B. $5 \leq x \leq 9$ C. $5 \leq x < 9$ D. $5 < x < 9$

35. Correct Computers, Inc. finds that the cost to make x laptop computers is $C = 1841x + 130,478$, while the revenue produced from them is $R = 2244x$ (C and R are in dollars). What is the smallest whole number of computers, x , that must be sold for the company to show a profit?

- A. 533,002,630 computers B. 52,582,634 computers C. 324 computers D. 32 computers

36. DG's Plumbing and Heating charges \$50 plus \$70 per hour for emergency service. Bill remembers being billed just over \$450 for an emergency call. How long, to the nearest hour, was the plumber at Bill's house?

- A. 6 hours B. 16 hours C. 7 hours D. 12 hours

37. Write the equation of the quadratic function whose graph is shown to the right.

- A. $y = (x - 1)^2 + 4$ B. $y = -(x + 1)^2 + 4$
 C. $y = -2(x - 1)^2 + 4$ D. $y = -(x - 1)^2 + 4$

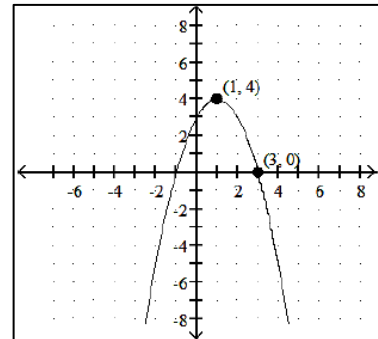

38. Write the equation of the quadratic function whose graph is shown to the right.

- A. $y = -(x - 3)^2 - 7$ B. $y = (x - 3)^2 - 7$
 C. $y = (x + 3)^2 - 7$ D. $y = -(x - 3)^2 + 7$

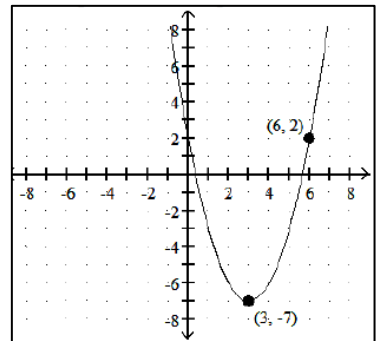

39. Give the coordinates of the vertex. $y = (x - 9)^2 + 4$

- A. (-9, 4) B. (-9, -4) C. (9, 4) D. (9, -4)

40. Give the coordinates of the vertex. $y = 2x^2 + 4x - 1$

- A. (-3, -1) B. (-1, -3) C. (1, 3) D. (3, 1)

41. Give the coordinates of the vertex. $y = (x - 1)^2$

- A. (0, -1) B. (1, 0) C. (-1, 0) D. (0, 1)

42. Give the coordinates of the vertex. $y = x^2 + 5$

- A. (0, -5) B. (-5, 0) C. (0, 5) D. (5, 0)

43. Determine the x -intercepts of the graph of $y = x^2 - x - 6$.

- A. (-1, 0), (-6, 0) B. (-2, 0), (3, 0) C. (-3, 0), (-2, 0) D. (-3, 0), (2, 0)

44. Determine the x -intercepts of the graph of $y = -x^2 + 2x + 35$.

- A. $(-7, 0), (5, 0)$ B. $(-35, 0), (-2, 0)$ C. $(-5, 0), (7, 0)$ D. $(5, 0), (7, 0)$

45. Determine the x -intercepts of the graph of $y = 4x^2 - 20x + 21$.

- A. $(6, 0), (14, 0)$ B. $(1.5, 0), (3.5, 0)$ C. $(-3.5, 0), (-1.5, 0)$ D. $(-29, 0), (21, 0)$

46. Determine the x -intercepts of the graph of $y = -2x^2 - 3x + 5$.

- A. $(-2.5, 0), (1, 0)$ B. $(-1, 0), (2.5, 0)$ C. $(-3, 0), (5, 0)$ D. $(-5, 0), (2, 0)$

47. Sketch a complete graph of the function $y = 3x^2 - 60x + 303$.

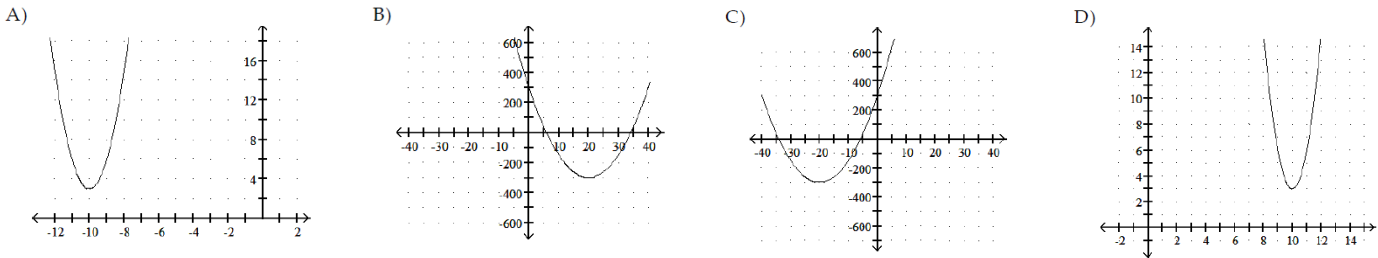

48. Give the coordinates of the vertex and graph the equation in a window that includes the vertex: $y = 2x^2 - 60x + 16$

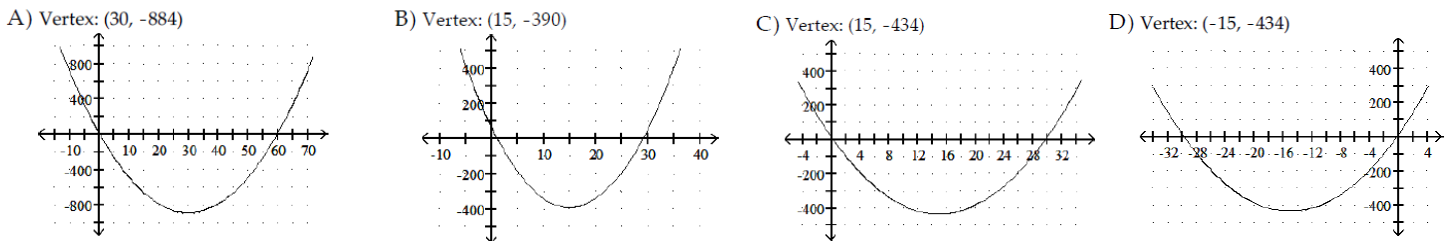

49. Give the coordinates of the vertex and graph the equation in a window that includes the vertex: $y = -0.2x^2 - 14x + 6$

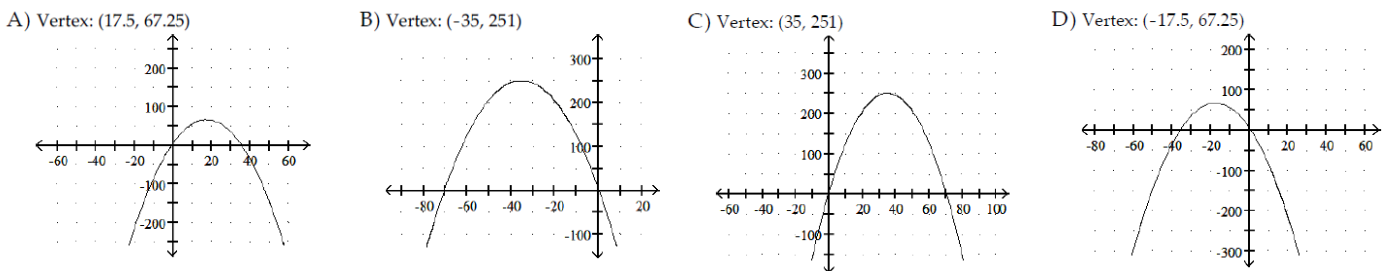

50. At Allied Electronics, production has begun on the X-15 Computer Chip. The total revenue function is given by $R(x) = 58x - 0.3x^2$ and the total cost function is given by $C(x) = 11x + 12$, where x represents the number of boxes of computer chips produced. The total profit function, $P(x)$, is such that $P(x) = R(x) - C(x)$. Find $P(x)$.

- A. $P(x) = -0.3x^2 + 36x + 12$ B. $P(x) = 0.3x^2 + 47x - 24$
 C. $P(x) = 0.3x^2 + 36x - 36$ D. $P(x) = -0.3x^2 + 47x - 12$

51. If a ball is thrown upward at 64 feet per second from the top of a building that is 180 feet high, the height of the ball can be modeled by $S = 180 + 64t - 16t^2$, where t is the number of seconds after the ball is thrown. After how many seconds does the ball reach its maximum height?
- A. 2 sec B. 5.6 sec C. 1 sec D. 4 sec
52. If a ball is thrown upward at 64 feet per second from the top of a building that is 180 feet high, the height of the ball can be modeled by $S = 180 + 64t - 16t^2$, where t is the number of seconds after the ball is thrown. What is the ball's maximum height?
- A. 372 ft B. 180 ft C. 228 ft D. 244 ft
53. Your company uses the quadratic model $y = -4.5x^2 + 150x$ to represent the average number of new customers who will be signed on x weeks after the release of your new service. How many new customers can you expect to gain in week 18.
- A. 621 customers B. -108 customers C. 1242 customers D. 2619 customers
54. Solve: $20x^2 + 33x + 10 = 0$
- A. $x = \frac{5}{4}, x = \frac{2}{5}$ B. $x = \frac{5}{4}, x = -2$ C. $x = -\frac{5}{4}, x = -\frac{2}{5}$ D. $x = -5, x = -\frac{2}{5}$
55. Solve: $x^2 - 9 = 0$
- A. ± 4 B. 4.5 C. 3 D. ± 3
56. Solve: $y^2 - 12 = 0$
- A. $\pm 2\sqrt{3}$ B. $\sqrt{12}$ C. 6 D. 144
57. Solve: $-7k^2 - 5 = -33$
- A. 2 B. -16.5 C. ± 4 D. ± 2
58. Solve: $6y^2 + 19y + 15 = 0$
- A. $-\frac{5}{3}, -\frac{3}{2}$ B. $\frac{5}{3}, -\frac{3}{2}$ C. $-\frac{5}{6}, -\frac{1}{5}$ D. $\frac{5}{3}, \frac{3}{2}$
59. Solve: $x^2 + 12x + 14 = 0$
- A. $-12 + \sqrt{14}$ B. $6 + \sqrt{22}$ C. $6 \pm \sqrt{14}$ D. $-6 \pm \sqrt{22}$
60. Solve: $p^2 - p - 4 = 0$
- A. $\frac{1 \pm \sqrt{15}}{2}$ B. $\frac{1 \pm \sqrt{17}}{2}$ C. $1 \pm \sqrt{17}$ D. ± 2

61. Solve: $6n^2 = -12n - 1$

A. $\frac{-6 \pm \sqrt{42}}{6}$

B. $\frac{-12 \pm \sqrt{30}}{6}$

C. $\frac{-6 \pm \sqrt{30}}{12}$

D. $\frac{-6 \pm \sqrt{30}}{6}$

62. Approximate solutions to the equation. Round your answers to three decimal places. $x^2 + 7x = -5$

A. 6.193, 0.807

B. -4.307, -4.307

C. -0.807, -6.193

D. 0.653, -7.653

63. If an amount of money, called the principal, P , is deposited into an account that earns interest at a rate, r , compounded annually, then in two years that investment will grow to an amount A , given by the formula $A = P(1 + r)^2$. If a principal amount of \$1000 grows to \$1,123.60 in two years, what is the interest rate?

A. 6%

B. 7%

C. 8%

D. 5%

64. A ball is thrown downward from a window in a tall building. The distance traveled by the ball in t seconds is $s = 16t^2 + 32t$ where s is in feet. How long (to the nearest tenth) will it take the ball to fall 80 feet?

A. 1.4 sec

B. 1.3 sec

C. 2.3 sec

D. 2.2 sec

65. Graph the function $f(x) = \frac{1}{x+1}$

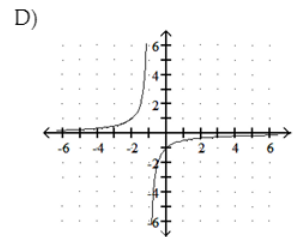
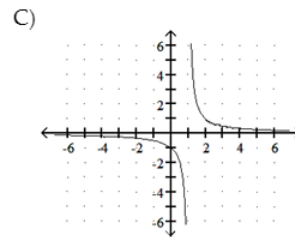
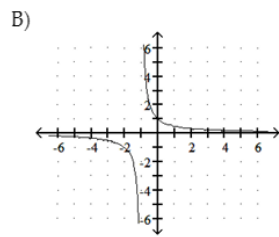
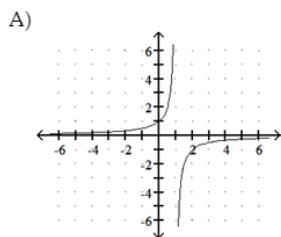

66. Graph the function $y = \sqrt{x} - 3$

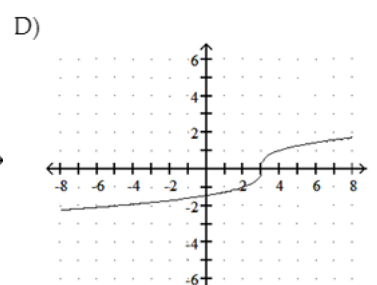
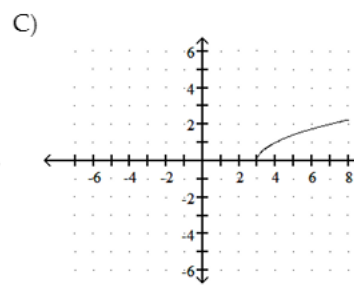
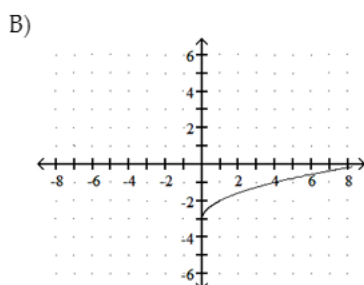
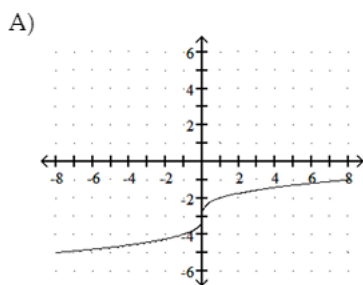

67. Evaluate $f(-2)$ for $f(x) = \begin{cases} 5x & \text{if } x \leq -1 \\ x - 7 & \text{if } x > -1 \end{cases}$

A. -9

B. -5

C. -10

D. 10

68. Evaluate $f(5)$ for $f(x) = \begin{cases} 4x + 4 & \text{if } x \leq 0 \\ 4 - 4x & \text{if } 0 < x < 4 \\ x & \text{if } x \geq 4 \end{cases}$

A. 4

B. 5

C. 24

D. -16

69. Evaluate $f(-3)$ for $f(x) = \begin{cases} x^2 - 4x - 4 & \text{if } x \leq -3 \\ x & \text{if } x > -3 \end{cases}$
- A. 1 B. 25 C. -3 D. 17
70. Suppose S varies directly as the cubed root of T , and that $S = 12$ when $T = 64$. Find T when $S = 9$.
- A. 12 B. 64 C. 27 D. 3
71. Suppose x varies inversely as y squared, and that $x = 6$ when $y = 8$. Find x when $y = 4$.
- A. 96 B. 2 C. 24 D. 72
72. If money is invested for 2 years with interest compounded annually, the future value of the investment varies directly as the square of $(1 + r)$, where r is the annual interest rate. If the future value of the investment is \$4759.04 when the interest rate is 4%, what rate gives a future value of \$4577.76?
- A. 0.02% B. 4% C. 2% D. 20%
73. Suppose a car rental company charges \$116 for the first day and \$66 for each additional or partial day. Let $S(x)$ represent the cost of renting a car for x days. Find the value of $S(3.5)$.
- A. \$231 B. \$281 C. \$347 D. \$314
74. The number of people present at a stadium holding a big rock concert can be estimated with the following function: $y = 13252x^{0.72} + 0.45x + 102$ where y is the number of people present and x is the number of hours after 3:00 pm on the day of the concert. Predict the number of people present at 7:00 pm.
- A. 53,901 people B. 38,270 people C. 36,060 people D. 36,059 people
75. The number of mice in an old barn after the cats are removed can be roughly estimated with the following function: $y = 2.325x^{0.79} + 0.25x + 1$, where y is the number of mice and x is the number of weeks since a cat lived in the barn. Predict the number of mice there will be in ten weeks if you get rid of the cat in the barn.
- A. 22 mice B. 18 mice C. 15 mice D. 17 mice
76. A study in a small town showed that the percent of residents who have college degrees can be modeled by the function $P = 37x^{0.39}$, where x is the number of years since 2010. Use numerical or graphical methods to find when the model predicts that the percent will be 74.
- A. 2017 B. 2018 C. 2016 D. 2015
77. The number of gears a machine can make varies directly as the time T it operates. If it can make 1,980 gears in 7 hours, how many gears can it make in 3 hours?
- A. 1,990 gears B. 0.0106 gears C. 282.86 gears D. 848.57 gears

78. The intensity of a radio signal from the radio station varies inversely as the square of the distance from the station. Suppose the intensity is 8000 units at a distance of 2 miles. What will the intensity be at a distance of 6 miles? Round your answer to the nearest unit.

- A. 853 units B. 872 units C. 915 units D. 889 units

79. The weight that a horizontal beam can support varies inversely as the length of the beam. Suppose that a 5-meter beam can support 350 kg. How many kilograms can a 10m beam support?

- A. 0.1429 kg B. 0.0057 kg C. 7 kg D. 175 kg

80. Sketch the graph of the pair of functions. Use a dashed line for $g(x)$. $f(x) = x^2$, $g(x) = -2(x + 5)^2 + 4$

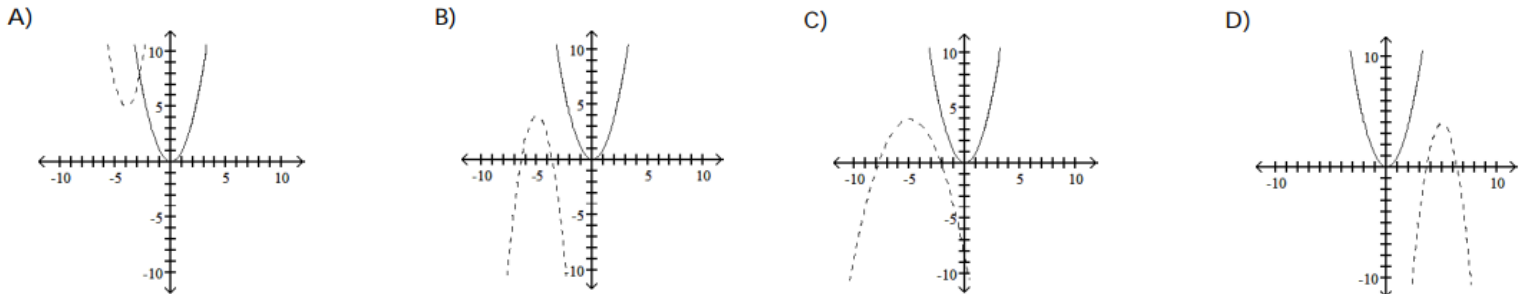

81. The graph of $y = -6(x - 4)^2 + 8$ can be obtained from the graph of $y = x^2$ by shifting horizontally _____ units to the _____, vertically stretching by a factor of _____, reflecting across the _____-axis, and shifting vertically _____ units in the _____ direction.

- A. 4; right; 6; x; 8; upward B. 4; right; 8; y; 6; downward
C. 4; left; 6; x; 8; upward D. 4; right; 8; x; 6; upward

82. The graph of $y = -6(x + 4)^2 - 8$ can be obtained from the graph of $y = x^2$ by shifting horizontally _____ units to the _____, vertically stretching by a factor of _____, reflecting across the _____-axis, and shifting vertically _____ units in the _____ direction.

- A. 4; right; 6; x; 8; downward B. 4; right; 6; x; 8; upward
C. 4; left; 8; x; 6; downward D. 4; left; 6; x; 8; downward

83. Write the equation of the graph after the indicated transformation(s): The graph of $y = x^2$ is shifted 8 units to the left and 10 units downward.

- A. $y = (x - 8)^2 - 10$ B. $y = (x + 8)^2 - 10$ C. $y = (x + 10)^2 - 8$ D. $y = (x - 10)^2 + 8$

84. Write the equation of the graph after the indicated transformation(s): The graph of $y = x^2$ is shifted 3 units to the right. This graph is then vertically stretched by a factor of 5 and reflected across the x -axis. Finally, the graph is shifted 7 units upward.

- A. $y = -5(x + 7)^2 + 3$ B. $y = -5(x + 3)^2 + 7$ C. $y = -5(x - 3)^2 + 7$ D. $y = -5(x - 3)^2 - 7$

85. The year, y , when sales were s million dollars for a particular electronics company can be modeled by the radical equation $y = 1.2\sqrt{s-2} - 7$, where $y = 1$ represents 2010, and so on. Use the model to predict the sales for 2015 to the nearest tenth of a million.
- A. \$121.4 million B. \$120.4 million C. \$119.4 million D. \$118.4 million
86. For $f(x) = 4x - 6$ and $g(x) = 2x - 9$ find $(f - g)(x)$.
- A. $2x - 15$ B. $2x + 3$ C. $-2x - 3$ D. $6x - 15$
87. For $f(x) = 9x - 1$ and $g(x) = 6x - 5$ find $(f \cdot g)(x)$.
- A. $15x^2 - 51x - 6$ B. $54x^2 + 5$ C. $54x^2 - 11x + 5$ D. $54x^2 - 51x + 5$
88. For $f(x) = 8x^2 - 9x$ and $g(x) = x^2 - 6x - 27$ find $\left(\frac{f}{g}\right)(x)$.
- A. $\frac{8x}{x+1}$ B. $\frac{8-x}{27}$ C. $\frac{8x^2-9x}{x^2-6x-27}$ D. $\frac{8x-9}{-6}$
89. For $f(x) = 2x - 5$ and $g(x) = \sqrt{x+7}$, what is the domain of $\left(\frac{f}{g}\right)(x)$?
- A. $[7, \infty)$ B. $[0, \infty)$ C. $(-7, 7)$ D. $(-7, \infty)$
90. For $f(x) = \sqrt{x-4}$ and $g(x) = x - 7$, what is the domain of $\left(\frac{f}{g}\right)(x)$?
- A. $[4, 7) \cup (7, \infty)$ B. $(4, 7) \cup (7, \infty)$ C. $[4, \infty)$ D. $[0, 7) \cup (7, \infty)$
91. If $f(x) = x + 3$ and $g(x) = 2x^2 + 12x + 4$, evaluate $(f \cdot g)(-2)$.
- A. -60 B. 60 C. -12 D. -16
92. Given $f(x) = -5x + 6$ and $g(x) = 6x + 9$, find $(g \circ f)(x)$.
- A. $30x + 45$ B. $-30x - 27$ C. $-30x + 51$ D. $-30x + 45$
93. Given $f(x) = |15 - x|$ and $g(x) = 3x + 8$, find $(f \circ g)(x)$.
- A. $|23 - 3x|$ B. $|7 + 3x|$ C. $|7 - 3x|$ D. $3|15 - x| + 8$
94. Find $(g \circ f)(-17)$ when $f(x) = \frac{x-7}{4}$ and $g(x) = 2x + 3$.
- A. $-\frac{19}{2}$ B. 186 C. -9 D. -30
95. Find $(f \circ g)(-5)$ when $f(x) = -5x + 9$ and $g(x) = 6x^2 - 8x + 8$.
- A. 6672 B. -81 C. -60 D. -981

96. The monthly total cost of producing clock radios is given by $C(x) = 36,000 + 23x$, where x is the number of radios produced per month. Find the monthly average cost function.

A. $\bar{C}(x) = \frac{36,000+23x}{x}$

B. $\bar{C}(x) = \frac{36,000+23}{x}$

C. $\bar{C}(x) = \frac{x}{36,000+23x}$

D. $\bar{C}(x) = x(36,000 + 23x)$

97. Let $C(x) = 100 + 30x$ be the cost to manufacture x items. Estimate the average cost to produce 80 items to the nearest dollar.

A. \$347

B. \$480

C. \$31

D. \$49

98. The cost of manufacturing clocks is given by $C(x) = 46 + 41x - x^2$. Also, it is known that in t hours the number of clocks that can be produced is given by $x = 10t$, where $1 \leq t \leq 12$. Express C as a function of t .

A. $C(t) = 46 + 410t - 100t$

B. $C(t) = 46 + 410t - 100t^2$

C. $C(t) = 46 + 41t + t^2$

D. $C(t) = 46 + 41t - 10$

99. Find the inverse of the function $f(x) = 5x - 3$

A. $f^{-1}(x) = \frac{x+3}{5}$

B. $f^{-1}(x) = \frac{x-3}{5}$

C. Not a one-to-one function

D. $f^{-1}(x) = \frac{x}{5} + 3$

100. Find the inverse of the function $f(x) = -9 - 2x$

A. $f^{-1}(x) = -7 - x$

B. $f^{-1}(x) = \frac{9}{2} - \frac{x}{2}$

C. $f^{-1}(x) = -\frac{9}{2} + \frac{x}{2}$

D. $f^{-1}(x) = -\frac{9}{2} - \frac{x}{2}$

101. Find the inverse of the function $f(x) = \frac{8}{x+7}$

A. Not a one-to-one function

B. $f^{-1}(x) = \frac{7+8x}{x}$

C. $f^{-1}(x) = \frac{x}{7+8x}$

D. $f^{-1}(x) = \frac{-7x+8}{x}$

102. The graph of the function $y = f(x)$ is given. On the same axes, sketch the graph of $f^{-1}(x)$. Use a dashed line for the inverse function.

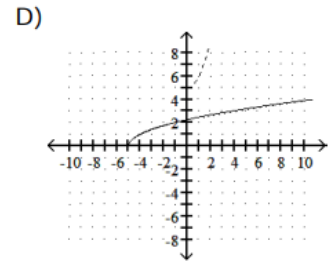
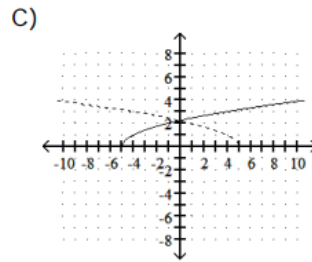
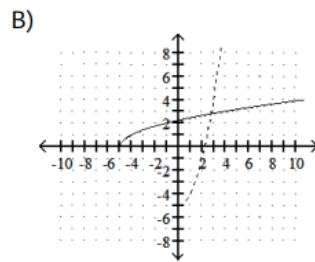
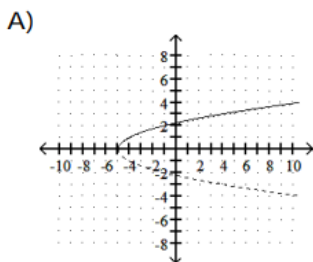
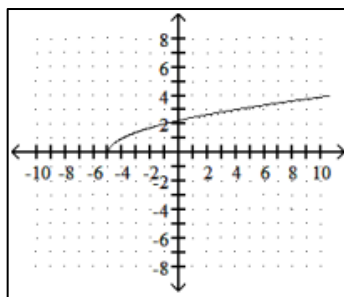

103. Let $f(x) = \left(\frac{1}{5}\right)^x$. Find $f(-3)$.

- A. -15 B. $-\frac{1}{125}$ C. $\frac{1}{125}$ D. 125

104. Let $f(x) = 3^{(1-x)}$. Find $f(4)$.

- A. -9 B. 27 C. $\frac{1}{27}$ D. $\frac{1}{9}$

105. Let $f(x) = 2.8e^{-2.3x}$. Find $f(0.8)$, rounded to four decimal places.

- A. 17.6303 B. -0.4447 C. -17.6303 D. 0.4447

106. Graph $f(x) = 5^{(x-1)}$

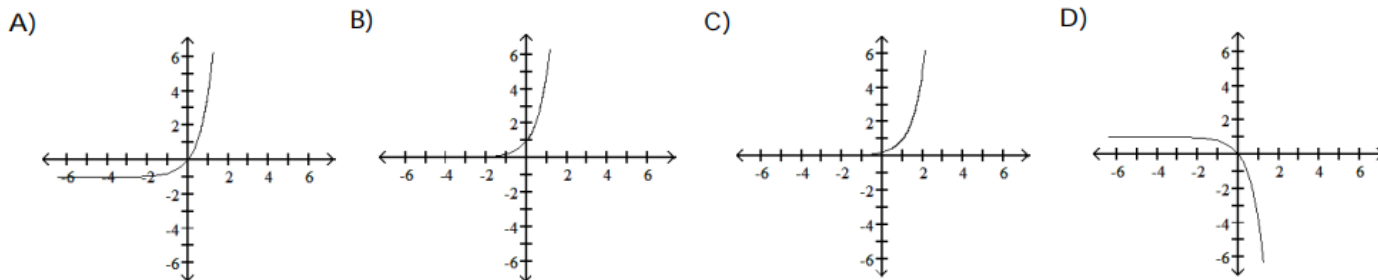

107. Graph $f(x) = 3e^{-x}$

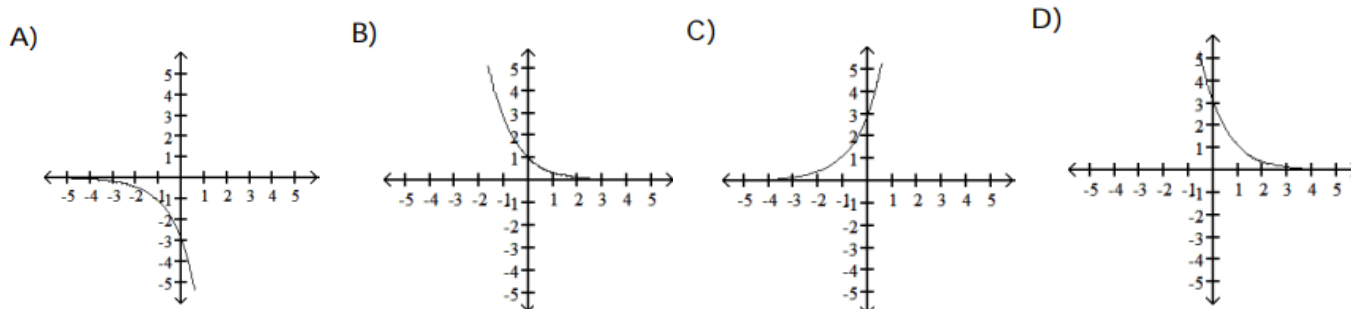

108. In September 1998 the population of the country of West Goma in millions was modeled by $f(x) = 17.9e^{0.0011x}$. At the same time, the population of East Goma in millions was modeled by $f(x)14.2e^{0.0185x}$. In both formulas x is the year, where $x = 0$ corresponds to September 1998. Assuming these trends continue, estimate the year when the population of West Goma will equal the population of East Goma.

- A. 2010 B. 2011 C. 1985 D. 13

109. In September 1998 the population of the country of West Goma in millions was modeled by $f(x) = 16.1e^{0.0019x}$. At the same time, the population of East Goma in millions was modeled by $f(x)14.7e^{0.0123x}$. In both formulas x is the year, where $x = 0$ corresponds to September 1998. Assuming these trends continue, estimate what the populations will be when the populations are equal.

- A. 1 million B. 14 million C. 15 million D. 16 million

110. The growth in the population of a certain rodent at a dump site fits the exponential function $A(t) = 708e^{0.024t}$, where t is the number of years since 1988. Estimate the population in the year 2000.

- A. 725 B. 967 C. 944 D. 472

111. A computer is purchased for \$4500. Its value each year is about 77% of the value the preceding year. Its value, in dollars, after t years is given by the exponential equation $V(t) = 4500(0.77)^t$. Find the value of the computer after 8 years.

- A. \$428.18 B. \$ 329.70 C. \$ 27, 720.00 D. \$556.08

112. Write the logarithmic equation in exponential form: $\log_W Q = 7$

- A. $Q^7 = W$ B. $W^7 = Q$ C. $7^W = Q$ D. $Q^W = 7$

113. Write the logarithmic equation in exponential form: $y = \log(11x)$

- A. $y^{10} = 11x$ B. $11x^y = 10$ C. $10^y = 11x$ D. $10^{11x} = y$

114. Write the logarithmic equation in exponential form: $4y = \ln(-5x)$

- A. $-5x^{4y} = e$ B. $e^{4y} = -5x$ C. $e^y = -\frac{5}{4}x$ D. $e^{-5x} = 4y$

115. Write in logarithmic form: $p = 18^t$

- A. $\log_{18} p = t$ B. $\log_p 18 = t$ C. $\log_t 18 = p$ D. $\log_{18} t = p$

116. Write in logarithmic form: $8^{3x} = y$

- A. $\log_8 y = 3x$ B. $\log_y 8 = 3x$ C. $\log_y 3x = 8$ D. $\log_8 3x = y$

117. Evaluate. Round the answer to four decimal places. $\log(3767)$

- A. 3.5760 B. 3.5771 C. 8.2340 D. 3.5748

118. Evaluate. Round the answer to four decimal places. $\ln 0.980$

- A. 0.0202 B. -0.0202 C. 0.0088 D. -0.0088

119. Evaluate. Round the answer to four decimal places. $\log(-2)$

- A. 0.6931 B. 0.3010 C. Does not exist D. 0.2408

120. Evaluate: $\log_9 \frac{1}{729}$

- A. 3 B. -81 C. 81 D. -3

121. Graph: $f(x) = \log_2(x - 2)$

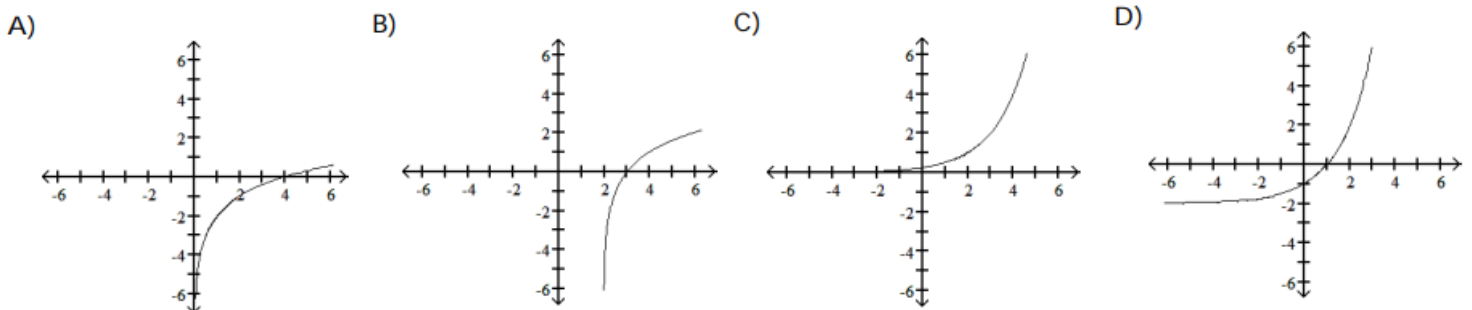

122. Use the properties of logarithms to evaluate the expression: $\log_a a^3$
- A. $3 \log_a a$ B. 3 C. 1 D. a^3
123. Use the properties of logarithms to evaluate the expression: $\ln e^6$
- A. 1 B. $6 \ln e$ C. 6 D. e^6
124. The sales of a new product (in items per month) can be approximated by $S(x) = 275 + 100 \log(3t + 1)$, where t represents the number of months after the first item becomes available. Find the number of items sold per month 3 months after the first item becomes available.
- A. 375 items per month B. 2275 items per month
C. 1275 items per month D. 475 items per month
125. Coyotes are one of the few species of North American animals with an expanding range. The future population of coyotes in a region of Mississippi can be modeled by the equation $P = 56 + 18 \ln(11t + 1)$, where t is time in years. Use the equation to determine when the population will reach 160. Round to the nearest tenth when necessary.
- A. 29.6 years B. 29.3 years C. 54,498.5 years D. 29.5 years
126. Solve. Round to three decimal places. $3^x = 23$
- A. 2.037 B. 7.667 C. 2.854 D. 0.350
127. Solve. Round to three decimal places. $5^{3x-3} = 20$
- A. 1.620 B. 1.462 C. 2.333 D. -0.380
128. Solve. Round to three decimal places. $5^{9-3x} = 125$
- A. 3 B. 25 C. 2 D. -2
129. Evaluate. Approximate to three decimal places. $\log_6(95.63)$
- A. 15.938 B. 2.545 C. 1.981 D. 0.393
130. Evaluate. Approximate to three decimal places. $\log_6(95.63)$
- A. 2.545 B. 10.791 C. -0.255 D. -3.052
131. Solve. Give an exact solution. $\log_3 x = -2$
- A. $\frac{1}{8}$ B. 1 C. $\frac{1}{9}$ D. -6
132. Solve. $232 + 6 \log x = 190$
- A. -10^7 B. no solution C. -70 D. 10^{-7}
133. Solve. $\log(x + 18) = 2$
- A. 100 B. 18 C. 2 D. 82

134. If the average cost per unit $C(x)$ to produce x units of plywood is given by $C(x) = \frac{900}{x+30}$, what is the unit cost for 10 units? Round to the nearest cent.

A. \$3.00

B. \$22.50

C. \$60.00

D. \$90.00

135. Suppose a cost-benefit model is given by $y = \frac{7.7x}{100-x}$, where y is the cost in thousands of dollars for removing x percent of a given pollutant. Find the cost of removing 45% to the nearest dollar.

A. \$818

B. \$3465

C. \$7700

D. \$6300

136. Solve the equation for x : $\frac{12}{x-4} = 1 + \frac{14}{x+4}$

A. $-10, 12$

B. No solution

C. $10, -12$

D. $-14, 12$

137. Solve the equation for x : $\frac{16}{x-4} = \frac{x^2}{x-4}$

A. 4

B. $4, -4$

C. -4

D. 16

138. Solve the equation for x : $\frac{8}{x+6} = -\frac{7}{9}$

A. No solution

B. $-\frac{110}{9}$

C. $-\frac{30}{7}$

D. $-\frac{114}{7}$

1. C	44. C	87. D	130. A
2. C	45. B	88. C	131. C
3. B	46. A	89. D	132. D
4. D	47. D	90. A	133. D
5. A	48. C	91. C	134. B
6. C	49. B	92. D	135. D
7. B	50. D	93. C	136. C
8. A	51. A	94. C	137. C
9. B	52. D	95. D	138. D
10. D	53. C	96. A	
11. A	54. C	97. C	
12. D	55. D	98. B	
13. B	56. A	99. A	
14. D	57. D	100. D	
15. D	58. A	101. D	
16. B	59. D	102. B	
17. C	60. B	103. D	
18. D	61. D	104. C	
19. C	62. C	105. D	
20. A	63. A	106. C	
21. D	64. A	107. D	
22. B	65. B	108. B	
23. C	66. B	109. D	
24. D	67. C	110. C	
25. B	68. B	111. D	
26. B	69. D	112. B	
27. A	70. C	113. C	
28. B	71. C	114. B	
29. C	72. C	115. A	
30. D	73. B	116. A	
31. B	74. D	117. A	
32. A	75. B	118. B	
33. B	76. C	119. C	
34. B	77. D	120. D	
35. C	78. D	121. B	
36. A	79. D	122. B	
37. D	80. B	123. C	
38. B	81. A	124. A	
39. C	82. D	125. B	
40. B	83. B	126. C	
41. B	84. C	127. A	
42. C	85. C	128. C	
43. B	86. B	129. B	